

the Paradise™ 9

BFP638 / SFP638



Sage®

EN USER GUIDE

BILT. × Sage®

Download on the
App Store

GET IT ON
Google Play





Contents

- 2 Sage® Recommends Safety First
- 6 Components
- 9 Assembly
- 12 Functions
- 13 Tips
- 15 Care & Cleaning
- 17 Troubleshooting
- 19 Guarantee

SAGE® RECOMMENDS SAFETY FIRST

At Sage® we are very safety conscious. We design and manufacture consumer products with the safety of you, our valued customer, foremost in mind. In addition we ask that you exercise a degree of care when using any electrical appliance and adhere to the following precautions.

IMPORTANT SAFEGUARDS

READ ALL INSTRUCTIONS BEFORE USE AND SAVE FOR FUTURE REFERENCE

- A downloadable version of this document is also available at sageappliances.com.
- Remove and safely discard any packaging materials and promotional labels before using the appliance.
- To eliminate a choking hazard for young children, remove and safely discard the protective cover fitted to the power plug of this appliance.
- Before using for the first time, please ensure that your electricity supply is the same as shown on the rating label on the underside of the appliance. If you have any concerns, please contact your local electricity company.
- Do not place the food processor near the edge of a bench or table or on a sink drain board during operation. Ensure the surface is level, clean and free of water, flour, etc. Vibration during operation may cause the appliance to move.
- Handle the food processor and attachments with care - remember the blades and discs are razor-sharp and should be kept out of reach from children.

- Care shall be taken when handling the sharp cutting blades, emptying the bowl and during cleaning.
- Always make sure the food processor is completely assembled, with the processing lid securely in position before operating. The appliance will not operate unless properly assembled.
- Ensure the OFF button has been pressed, and the food processor is switched off at the power outlet and unplugged before attaching any accessories or processing lid.
- To unplug, grasp the plug and pull from the outlet. Never pull from the power cord.
- Always secure the processing bowl onto the motor base before attaching the blades or discs.
- Do not push food into the feed chute with your fingers or other utensils. Always use the food pusher provided.
- Keep hands, knives and other utensils away from moving blades or discs.
- Do not place hands or fingers in the bowl of the food processor unless the motor, blades or discs have come to a complete stop.
- To reduce the risk of fire or electric shock, or injury, do not use attachments other than those provided with the food processor.
- Do not attempt to operate the food processor by any method other than those described in this booklet.
- Do not place the appliance on or near a hot gas or electric burner, or where it could touch any other source of heat.
- Ensure the motor, blades or discs have completely stopped before disassembling.
- Ensure the OFF button has been pressed and the appliance is switched off at the power outlet and unplugged from the power outlet when not in use, if left unattended and before disassembling, cleaning, or storing.
- Care should be taken when removing the food from the processing bowl by ensuring the motor, blades or discs, have completely stopped before disassembling. The processing bowl should then be unlocked from the motor body and the blades, dough blade or disc carefully removed before attempting to remove the processed food.
- Please do not crush ICE in the processing bowl. This will cause damage to the blades. We recommend that you use a blender for ice crushing.
- Some stiff mixtures, such as dough may cause the processing blade to rotate more slowly than normal. If this happens, do not process for longer than 1 minute.

- Do not process hot or boiling liquids - allow liquids to cool before placing into the processing bowl. Hot liquid can be ejected to cause injury due to sudden steaming.
- Do not move the food processor whilst in operation.
- Do not leave the food processor unattended when in use.
- Do not place any part of the food processor in the microwave oven.
- Do not fill the processing bowl above the marked maximum fill line for each type of the ingredients. Always add drier or thicker ingredients to the processing bowl prior to adding fluids. Failing to follow this instruction may cause product malfunction, product damage or personal injury due to damage to the cover or bowl.
- Keep the appliance clean. Do not use harsh abrasive, caustic cleaners when cleaning the appliance. Follow the cleaning instructions provided in this book.
- touch hot surfaces or become knotted.
- This appliance shall not be used by children. Keep the appliance and its cord out of reach of children. Appliance can be used by persons with reduced physical, sensory or mental capabilities or lack of experience and knowledge if they have been given supervision or instruction concerning use of the appliance in a safe way and if they understand the hazards involved.
- Children should be supervised to ensure they do not play with the appliance.
- Cleaning and user maintenance shall not be made by children without supervision.
- It is recommended to regularly inspect the appliance. Do not use the appliance if power supply cord, plug or appliance becomes damaged in any way. Return the entire appliance to the nearest authorised Sage Service Centre for examination and/or repair.

IMPORTANT SAFEGUARDS FOR ALL ELECTRICAL APPLIANCES

- Fully unwind the power cord before use.
- Do not let the power cord hang over the edge of a table, counter,
- For safety reasons it is recommended you plug your appliance directly into its own electrical outlet on a dedicated circuit separate from other appliances. If the electric circuit is overloaded with other appliances, your appliance may not function properly.

- Never store any blade or disc on motor shaft. To reduce the risk of injury, never place cutting blade or discs on the shaft without first putting bowl properly in place. Store blades and discs, as you would sharp knives, out of reach of children in the storage box provided.
- This appliance is for household use only. Do not use this appliance for anything other than its intended use. Do not use in moving vehicles or boats. Do not use outdoors. Misuse may cause injury.
- The processing blades and discs are extremely sharp, handle with care at all times. Avoid contact with moving parts during operation. Keep hands, hair, clothing, spatulas and other utensils out of food processor feed chute to prevent personal injury or damage to the appliance. Always use the food pusher to push the food down the feed chute.
- To avoid a hazard due to inadvertent resetting of the thermal cut-out, this appliance must not be supplied through an external switching device, such as a timer, or connected to a circuit that is regularly switched on and off by the utility.
- The installation of a residual current device (safety switch) is recommended to provide additional safety protection when using electrical appliances. It is advisable that a safety switch with a rated residual operating current not exceeding 30mA be installed in the electrical circuit supplying the appliance. See your electrician for professional advice.



WARNING

To avoid possible malfunction of the processing bowl's auto switch, do not place the processing lid in the locked position when the appliance is not in use.



To protect against electric shock or fire, do not immerse the power cord, power plug or appliance in water or any other liquid.



The symbol shown indicates that this appliance should not be disposed of in normal household waste.

It should be taken to a local authority waste collection centre designated for this purpose or to a dealer providing this service. For more information, please contact your local council office.

FOR HOUSEHOLD USE ONLY SAVE THESE INSTRUCTIONS



Components

A. Small pusher cap

The small pusher cap functions as a cover of the smaller feed chute.

B. Small food pusher

For improved processing control of smaller ingredients. It also doubles as a measuring cup. The food processor will run continually whether the small pusher is in or out.

C. Large food pusher

For pushing food down the feed chute. The food processor will not start unless the large pusher is correctly in place.

D. Feed chute safety system

Prevents the motor from operating unless the bowl and lid are correctly locked in position, and large feed pusher is inserted.

E. Processing Lid with silicone seal

Locks onto the processing bowl.

F. Main bowl with handle

The bowl locks onto the motor base.

G. POWER button

H. PULSE button

Press down and hold briefly for short bursts of power. The motor will automatically stop after the PULSE button has been released.

I. PLAY | STOP button

Press to start and stop the motor.

J. Powerful induction motor base

Induction motor with safety braking system.

K. Non-skid rubber feet

For added safety and stability.

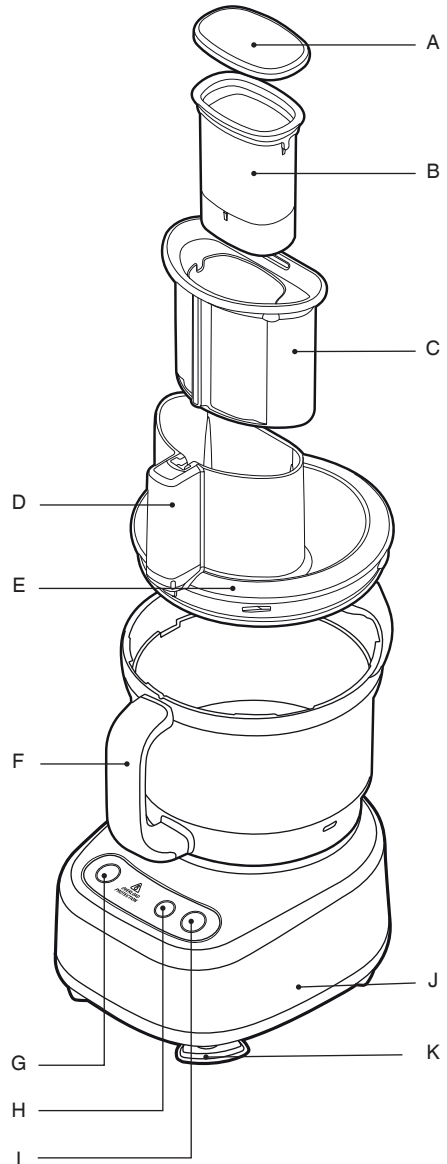

Rating Information

220 - 230 V ~ 50 Hz 650 W

1. Dicing Blade

To be used with the dicing grid for dicing in cubes.

2. Dicing Grid

To be used with the dicing blade for dicing in cubes.

3. Dicing Cleaner

Use to clean dicing grid.

4. Main Spindle

Attaches to blade or discs.

5. Dicing Gearbox

Use with the dicing kit.

6. Reversible Shredder

Use one side of this disc for fine shredding and the other side for coarse shredding.

7. Adjustable Slicer

Use this disc for slicing ingredients. Able to slice from 0.3 mm – 5.0 mm thick.

8. S-Blade™

For swiftly chopping, mixing, and blending a variety of ingredients.

9. Dough blade

Soft material blade for kneading dough.

10. Caddy

To store all accessories.

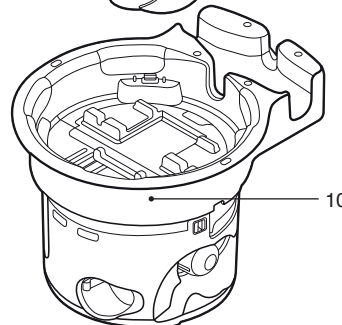
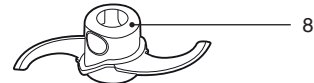
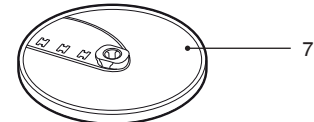
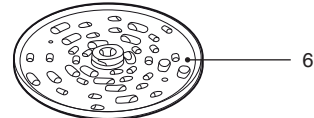
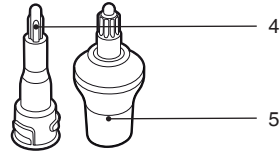
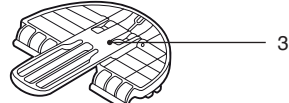
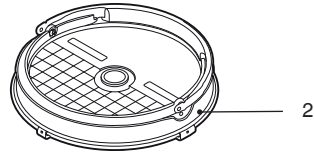
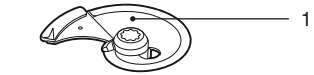
**TIP**

How to remove the caddy from the bowl?
With the lid sitting on the Caddy, grasp the outer rim of the caddy below where the lid sits and lift caddy out of bowl. Then, lift the lid off the caddy to access the accessories.

DETACHMENT AND ATTACHMENT OF ACCESSORIES

- Accessories all have a place in the caddy which has been color coordinated.
- All accessories can be accessed independently of each other.

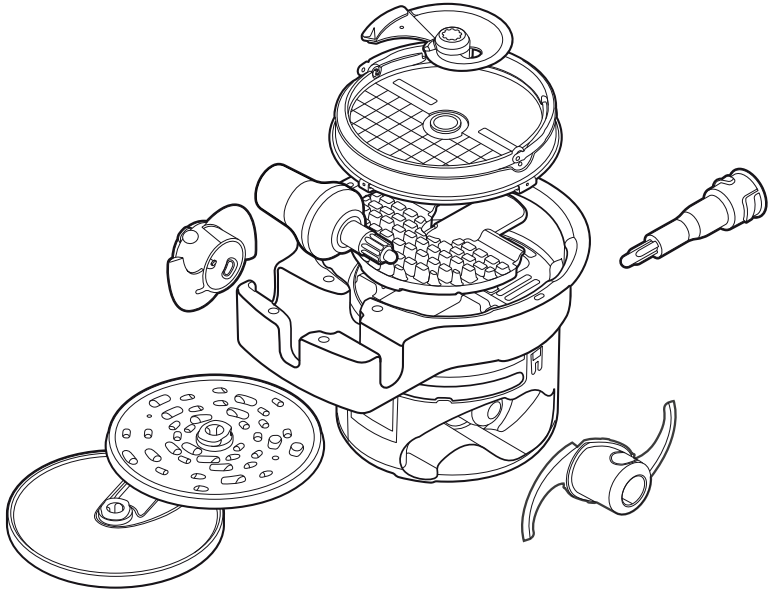



Assembly

BEFORE FIRST USE

- Before using your food processor for the first time, remove any packaging material and promotional labels. Ensure the POWER button is OFF and the food processor is unplugged.
- Be careful when handling the blades and discs as they are extremely sharp.
- Wash the processing bowl, processing lid and all attachments in warm soapy water with a soft cloth. Rinse and dry thoroughly. All attachments except the dicing gearbox, food pusher and food pusher lid may be washed in the dishwasher.
- When first using your food processor, you may notice an odour coming from the motor. This is normal and will dissipate with use.
- Always use the food processor on a dry, level work surface.

ASSEMBLY

Motor Base and Bowl

1. Position the processing bowl onto the motor base with the handle in line with the ALIGN HANDLE graphic on the motor base.

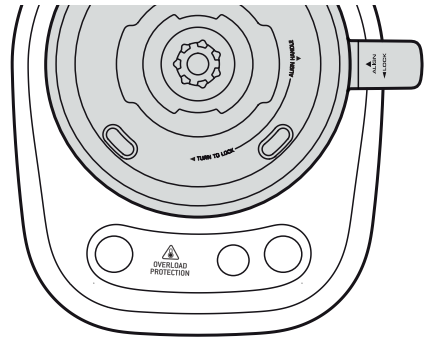

2. Turn the bowl clockwise until the handle locks to the front. The processing bowl should now be securely locked into position. The food processor will not operate unless the bowl is locked into position correctly.

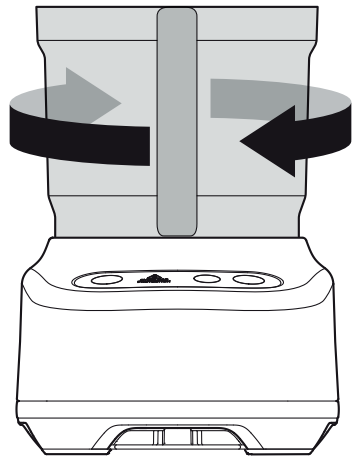

Spindles and Discs



WARNING

Do not touch the blades of the Dicing Grid and Dicing Blade. They are extremely sharp.



S blade
to spindle

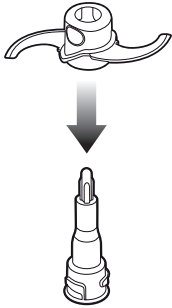

Dough blade
to spindle

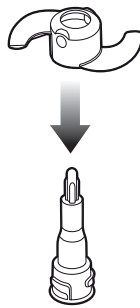

1. First is to assemble your chosen attachment (S blade or Dough blade) over the spindle and place them in position over the coupling in the centre of the processing bowl; then, place the lid onto the processing bowl.
2. The dicing gearbox is required when using the dicing kit. To dice vegetables or fruit, insert the dicing gearbox into the bowl first, followed by the dicing grid, ensuring to align with the 4 tabs in the bowl, place the dicing blade onto the dicing grid, over the dicing gearbox. Ensure the flat section of the blade (blade end) lines up with the 'insert blade' area of the grid.

Spindle and S Blade

1. Carefully insert the S blade into the spindle and turn clockwise until it is firmly locked in place.
2. Place the assembled spindle and S blade over the coupling in the centre of the bowl with caution. Avoid touching the blades.

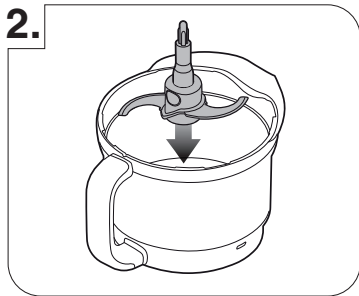
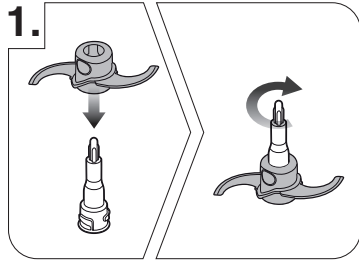

Spindle and Dough Blade

1. Insert the dough blade into the spindle and turn clockwise until it is firmly locked in place.
2. Place the assembled spindle and dough blade over the coupling in the centre of the bowl.

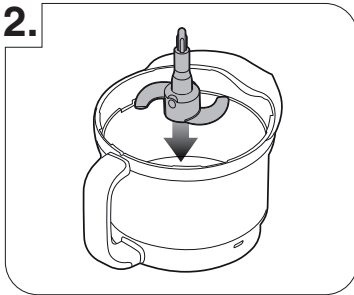
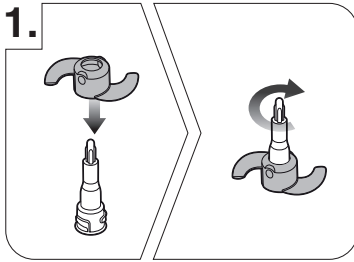

Lid

Place lid onto the processing bowl. To LOCK the lid, hold the chute and turn clockwise so that the handle parts align. Locking the lid correctly will engage the interlocking safety catch on.

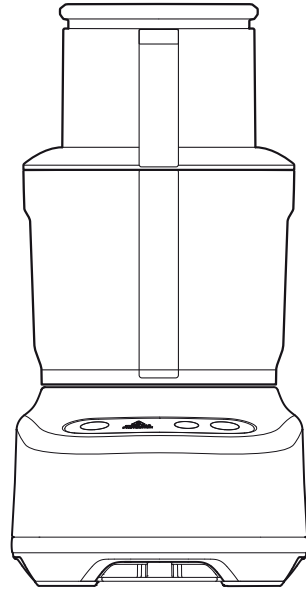

Dicing Assembly

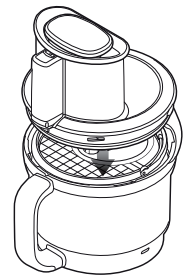
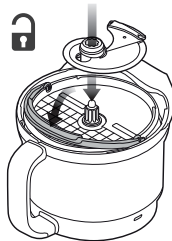
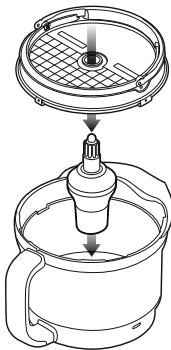



Functions

OPERATION

Getting started

The food processor will only operate when the processing bowl, lid and large pusher are correctly assembled. This engages the safety interlock, and allows the motor to run.

The chute has a CHUTE FILL MAX graphic to indicate the maximum volume of food that can be placed in the chute for the pusher to activate the safety locking catch.

Control Panel

When the machine is connected to power, and the POWER button is pressed; the buttons will illuminate and the food processor will be ready to operate.

Pressing the POWER button at this stage will turn the unit off.

Pressing the PLAY | STOP button will start the motor running continuously.

Press PLAY | STOP again while processing and the motor will stop.

Press PLAY | STOP to continue processing or press POWER to return to standby.

Removing the large pusher during processing will stop the motor. Ingredients can be added into the lid chute, and when the large pusher is re-inserted, the unit will continue to process.

Pressing the PULSE button will cause the motor to operate only while the button is held down.

Use a combination of the PULSE and PLAY | STOP buttons for more control when processing ingredients.

After Processing

Wait until the blades or discs have stopped moving before unlocking the lid. Ensure that the unit has been turned off using the POWER button and unplug from the power outlet before handling the blades.

When removing the blades or discs, lift the part by carefully gripping the plastic hub area in the center.

Overload Protection System

The food processor has an overload protection system to prevent damage to the motor - this will cause the food processor to go into standby mode.

Unplug the food processor and allow to cool for 30 minutes.

If the blades or discs stall while processing, immediately stop the machine, then unplug from the power outlet before clearing the wedge ingredients. If this happens more than once, the bowl may be overloaded. Try processing in smaller batches.



Tips

Tips listed below are suggestions only. For more detailed instructions, refer to specific recipes provided online at sageappliances.com

ACCESSORY	ACTION	TYPES OF INGREDIENTS / DISHES	TIPS
S-Blade™	Chop	<ul style="list-style-type: none"> • Raw fruits and vegetables • Raw or cooked meats and fish • Fresh herbs • Breadcrumbs • Nuts • Dried fruits 	<ul style="list-style-type: none"> • Trim and cut food, if necessary, into 2.5cm cubes before processing.
	Mince / Ground Meat	<ul style="list-style-type: none"> • Raw and cooked proteins 	<ul style="list-style-type: none"> • Trim and cut food into 2.5 cm cubes before processing. • For best results, freeze meat for 30 minutes. • Trim excess fats and sinew.
	Puree / Blend	<ul style="list-style-type: none"> • Cooked fruit and vegetables 	<ul style="list-style-type: none"> • Allow food to cool before pureeing or blending.
	Mix	<ul style="list-style-type: none"> • Sauces • Batters • Pesto • Compound butters 	<ul style="list-style-type: none"> • For batters, use PULSE button until mixed evenly. Do not over process.
Dough Blade	Knead	<ul style="list-style-type: none"> • Bread and pizza doughs 	<ul style="list-style-type: none"> • Add liquid through small feed chute whilst the motor is running to incorporate. • Recommended Recipe <ul style="list-style-type: none"> - 375 g flour - 7 g salt - 8 g yeast - 235 g of water - 10 g sugar • Maximum flour quantity = 575 g
Adjustable Slicer Disc	Slice	<ul style="list-style-type: none"> • Raw foods and vegetables • Salamis and deli meats 	<ul style="list-style-type: none"> • Place ingredients vertically on the left side of appropriate sized feed chute to minimize tilting. • For deli meats like salami or pepperoni, trim one end and process one at a time.
Reversible Shredding Disc	Coarse and Fine Shred	<ul style="list-style-type: none"> • Cheeses • Fruits and vegetables such as apples, potatoes, and cabbage 	<ul style="list-style-type: none"> • For best results, freeze softer cheeses for 45 minutes before grating.
			<div style="display: flex; align-items: center;"> <div> <p>NOTE</p> <p>Grating soft white cheeses such as fresh mozzarella is not recommended.</p> <ul style="list-style-type: none"> • Remove the rind from hard cheeses before grating. </div> </div>
Dicing kit	Dicing	<ul style="list-style-type: none"> • Raw and cooked vegetables and fruits 	<ul style="list-style-type: none"> • Use small feed chutes for harder ingredients such as carrot or pumpkin. To further improve results you can also pre cook. • When dicing tomatoes, avocados firmer fruit will give a better result.



IMPORTANT NOTES

Due to the harder and more fibrous nature; **DO NOT DICE** the following:

- Cheese
- Raw sweet potato / kumara.
- Meat including hard deli meats.
- Fruit and vegetables with tough skin such as pineapple and watermelon. These should be peeled first.

Do not fill the Bowl with ingredients above the MAX level on the side of the bowl.



IMPORTANT NOTES

For optimal results, use the chute size appropriate to the food to be processed, position food in the chute and use the pusher to push food with light downward force prior to starting the food processor.

Pressure

When processing, never force the food down the chute as this can damage the discs. Apply light, even pressure for soft foods such as tomatoes and bananas. Apply medium, even pressure for firmer foods such as potatoes, cheese, deli meats and apples.



NOTE

If food produce does get stuck inside the chute, remove the pusher, remove the lid from the bowl, and while the chute is away from the bowl and away from the blades; carefully dislodge the food stuck inside the chute by hand.

Smaller Ingredients

For long thin foods such as carrots, cucumbers, zucchini, etc., use the small feed chute. This will avoid the ingredient from tipping over, during slicing.

Larger Ingredients

The wide feed chute is 12cm wide and can fit ingredients up to this size. The food should fit snugly so it is supported in an upright position in the chute, but not so tight that it could prevent the food from moving down the chute. Ensure not to overfill the chute, as the pusher will not activate the interlock safety catch if the chute is too full. Do not fill over the MAX indicator.



Care & Cleaning

Remove the power cord from the power outlet after use for safety reasons.

Processing bowl and lid

Due to the interlock components, we do not recommend immersing the bowl and lid in water for long periods.

To keep your bowl and lid clean, and to avoid food drying, follow these steps as soon as possible after use:

- Rinse most of the ingredients off the bowl and lid.
- Hand wash in clean warm, soapy water using a mild liquid detergent and non-abrasive sponge.
- The processing bowl and lid may occasionally be washed in the dishwasher (top shelf only), however washing in the dishwasher is not recommended on a regular basis, as prolonged exposure to harsh detergents, hot water and pressure will damage and shorten the life of the plastic and the interlock components.



WARNING

Oils in citrus rind can damage the material of your food processor bowl if being exposed to it for a longer period. Always clean your processing bowl immediately after processing citrus rind.



WARNING

Do not touch the blades of the Dicing Grid. They are extremely sharp.

Dicing gear box and accessory caddy

Dicing gear box and accessory caddy (if needed) should only be hand washed.

Blades and discs

- Blades and discs are razor sharp, do not touch. Always use a spatula or brush to remove food or when cleaning blades.
- Spindle, blades and discs can be washed in the dishwasher.

Removal of Dicing Blade

1. With the lid removed from the bowl, use your thumb and forefinger to carefully grasp the dicing blade hub.
2. Lift up and simultaneously twist off the dicing gearbox and set aside.



NOTE

If you cannot remove the blade, return the lid onto the bowl, place the large pusher into the lid feed chute and press the pulse button until you see the blade tip stop in the 'insert blade' area.

Then, repeat steps above.

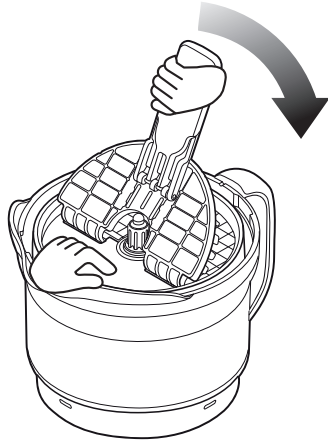
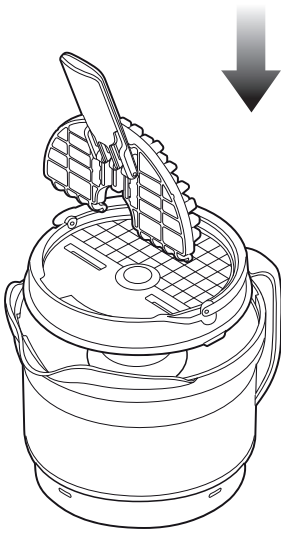

Cleaning the Dicing Grid



NOTES

- Ensure dicing blade has been removed first.
 - The dicing grid must remain correctly assembled to the bowl prior to using the dicing cleaner.
 - The dicing gearbox can remain inside the bowl and grid.
1. Take cleaner out of caddy and flip up handle.
 2. Align and then insert cleaner tabs into grid slots making sure the cleaner is upright.
 3. With one hand, grasp the cleaner handle. With your other hand, put pressure/hold down the blank side of the grid.
 4. Push the cleaner handle down towards the bowl rim, maintaining pressure on the grid with your other hand - Food should begin to be pressed through the grid and into the bowl.
 5. Continue to push down with the handle until you feel the resistance of the food cease and you cannot push any further.
 6. Lift the handle back up and remove the cleaner from the grid slots. Repeat the process if any large pieces still remain.



NOTE

Any small food pieces remaining can be removed by washing brush or rinsing in the sink.

Motor base

To clean the motor base, wipe with a soft, damp cloth then dry thoroughly. Wipe any excess food particles from the power cord.

Cleaning agents

Do not use abrasive scouring pads or cleansers on either the motor base or the bowls, as they may scratch the surface. Use only warm soap water with a soft cloth.

Stubborn food stains and odours, strong smelling foods such as garlic, fish and some vegetables such as carrots may leave an odour or stain the bowl or lid. To remove, pour warm soapy water (do not overfill). Set aside to soak for 5 minutes, without immersing the whole bowl. Then wash with a mild detergent and warm water, rinse well and dry thoroughly. Store the bowl with the lid off.



Troubleshooting

PROBLEM	EASY SOLUTION
Food is unevenly processed	<ul style="list-style-type: none"> • Ingredients should be cut evenly into 2.5 cm pieces before processing. • Ingredients should be processed in batches to avoid overloading.
Slices are slanted or uneven	<ul style="list-style-type: none"> • Place evenly cut food into the feed chute. • Apply even pressure on the pusher.
Food falls over in the feed chute	<ul style="list-style-type: none"> • There are two chute sizes for appropriate size of produce. Ensure the food is packed snugly for best results.
Some food remains on top of the disc after processing	<ul style="list-style-type: none"> • It is normal for small pieces to remain after processing.
Motor slows down when kneading dough	<ul style="list-style-type: none"> • Amount of dough must not exceed maximum recommended quantity on the recipe. Remove half and process in two batches. • Dough may be too dry. If motor speeds up, continue processing. If not, add more water, 1 tablespoon at a time until the motor speeds up. Process until dough cleans the side of the processing bowl.
Dough doesn't clear inside of the processing bowl	<ul style="list-style-type: none"> • Amount of dough may exceed food processor maximum capacity. Remove half and process in two batches. • Dough may be too dry.
Dough nub forms on top of dough blade and dough does not become uniformly kneaded	<ul style="list-style-type: none"> • Stop machine, carefully remove dough, divide it into 3 pieces and redistribute them evenly in the processing bowl.
Dough feels tough after kneading	<ul style="list-style-type: none"> • Divide dough into 2 or 3 pieces and redistribute evenly in processing bowl. Process 10 seconds or until uniformly soft and pliable. Allowing dough to rest allows the gluten strands to relax and become more pliable.
Dough is too dry	<ul style="list-style-type: none"> • While machine is running, add water through the small feed chute, 1 tablespoon at a time until dough clears the inside of the processing bowl.
Dough is too wet	<ul style="list-style-type: none"> • While machine is running, add flour through the small feed chute, 1 tablespoon at a time until dough clears the inside of the processing bowl.
The motor does not start	<ul style="list-style-type: none"> • There is a safety interlock switch to prevent the motor from starting if it is not properly assembled. Make sure the processing bowl lid and large pusher are securely locked into position. • The food content in the feed chute should be below the maximum fill line. • If the motor still will not start, check the power cord and power outlet.
The food processor shuts off during operation	<ul style="list-style-type: none"> • The lid may have become unlocked; check to make sure it is securely in position. • If the motor overloads, the 'OVERLOAD PROTECTION' icon in the screen will start to flash. Switch off by pressing the POWER button and unplug the power cord. Allow the food processor to cool for 30 minutes before resuming.
The motor slowed down during operation	<ul style="list-style-type: none"> • This is normal as some heavier loads (e.g. slicing / shredding cheese) may require the motor to work harder. Reposition the food in the feed chute and cut the food into smaller sizes and process using a smaller pusher and continue processing. • The maximum load capacity may have been exceeded. Remove some of the ingredients and continue processing.

PROBLEM

EASY SOLUTION

The food processor vibrates / moves during processing

- Make sure the rubber feet at the bottom of the unit are clean and dry. Also make sure that the maximum load capacity is not being exceeded.
- This is normal as some heavier loads may require the motor to work harder.
- Turn the unit off and clear any ingredients that may be caught on the disc, before continuing.
- If this occurs while mixing dough - then turn unit off and redistribute the dough mixture more evenly around the bowl before continuing.
- Process hard and fibrous foods such as carrots, through the small chute.

Dicing blade stuck on spindle

- Place lid back onto bowl and insert large pusher.
- Press the pulse button once and check if the blade is aligned to the 'insert blade' area. If not, repeat until it is - you may need to remove the lid to confirm.
- With the lid removed and blade in the correct position, carefully grasp the blade hub with thumb and forefinger. Then, lift the blade upwards and off the spindle.

For pro-tips and more information scan the QR Code.



QR SFP638

BILT. x Sage





Guarantee

2 YEAR LIMITED GUARANTEE

Sage Appliances guarantees this product for domestic use in specified territories for 2 years from the date of purchase against defects caused by faulty workmanship and materials. During this guarantee period Sage Appliances will repair, replace, or refund any defective product (at the sole discretion of Sage Appliances).

All legal warranty rights under applicable national legislation will be respected and will not be impaired by our guarantee. For full terms and conditions on the guarantee, as well as instructions on how to make a claim, please visit www.sageappliances.com.

GBR

BRG Appliances Limited
86–90 Paul Street, London, EC2A 4NE,
United Kingdom

Freephone (UK Landline): 0808 178 1650
Mobile Calls (National Rate): 0333 0142 970

DEU**AUT**

Sage Appliances GmbH
Campus Fichtenhain 48, 47807 Krefeld,
Deutschland

Deutschland: 0800 505 3104
Österreich: 0800 80 2551

FRA

Sage Appliances France SAS
Siège social: 66 avenue des Champs
Élysées – 75008 Paris
879 449 866 RCS Paris
France: 0800 903 235

IRE

Ireland
1800 932 369

NLD

Netherlands
0800 020 1741

ITA

Italy
800 909 773

ESP

Spain
900 838 534

PTR

Portugal
0800 180 243

POL

Poland
00800 121 8713

BEL

Belgium
0800 54 155

CHE

Switzerland
0800 009 933

LUX

Luxembourg
800 880 72

DNK

Denmark
80 820 827

SWE

Sweden
0200 123 797

FIN

Finland
0800 412 143

NOR

Norway
80 024 976

Sage®

www.sageappliances.com

Registered in England & Wales No. 8223512
Registered in Germany No. HRB 81309 (AG Düsseldorf)
Registered in France No. 879 449 866 RCS

EN Due to continued product improvement, the products illustrated or photographed in this document may vary slightly from the actual product.

DE Aufgrund unserer kontinuierlichen Produktverbesserungen kann die hier gezeigte Abbildung geringfügig vom tatsächlichen Produkt abweichen.

FR En raison de leur amélioration continue, les produits représentés ou photographiés dans le présent document peuvent différer légèrement du produit réel.

NL Vanwege voortdurende productverbeteringen, kunnen de afgebeelde producten in dit document licht afwijken van het eigenlijke product.

IT A causa del continuo miglioramento dei prodotti, il prodotto descritto o illustrato in questo documento può variare leggermente rispetto al prodotto reale.

ES Perfeccionamos nuestros productos continuamente, por lo que el artículo podría diferir ligeramente de la ilustración o la fotografía en este documento.

PT Devido à melhoria contínua dos produtos, os produtos ilustrados ou fotografados neste documento podem variar ligeiramente do produto real.

PL Ze względu na stałe przeprowadzane ulepszenia, produkty przedstawione na ilustracjach lub zdjęciach w tym dokumencie mogą różnić się od używanego produktu.

DA På grund af løbende produktudvikling kan de illustrerede eller fotograferede produkter i dette dokument variere en smule fra det faktiske produkt.

SV På grund av kontinuerlig produktförbättring kan produkterna som visas i illustrationerna och fotografierna i detta dokument skilja sig något från den faktiska produkten.

FI Jatkuvan tuotekehittelyn seurauksena kuvituksen tuotteet eivät välttämättä ole täysin samanlaisia kuin varsinaiset tuote.

NO På grunn av kontinuerlig produktutvikling kan produktene som er vist eller avfotografert i dette dokumentet, variere noe fra det faktiske produktet.

Copyright BRG Appliances 2023

BFP638 / SFP638 UK UG1 - B23